

Varenummer: 0109062
 Beskrivelse: Seeger låsering AS 45X2.5
 Fjederstål
 Note: Monteres med ZGA tang

Mål

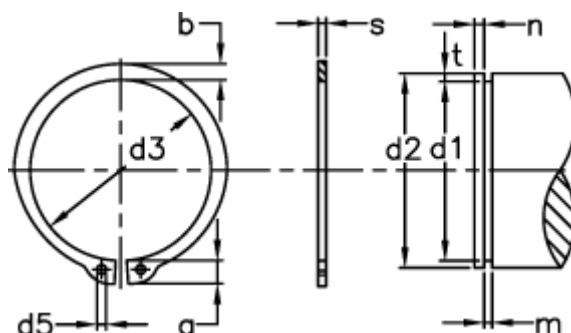

a max	= 7.5	d5 min	= 2.5	s	= 2.50
AN mm ²	= 172.0	FN kN	= 28.60	t	= 1.25
B	= 2.04	FRg kN	= 19.1	Tang	= ZGA-3
b	= 4.7	FR kN	= 100.0	tol	= -0.07
Betegnelse	= AS 45	g	= 2.0	tol	= +0,39 -0,90
d1	= 42.5	m min	= 2.65	tol	= -0.25
d2	= 45	n abl x 1000	= 11	vægt kg/1000	= 10.80
d3	= 41.5	Nominel træk	= 3.8		